















farmer

137 | 167 | 207 | 237 | 257

-  **IMPIEGO:** Idonea per la pulizia di banchine stradali, bordi e sponde di fossati.
-  **USE:** Suitable for cleaning quay and side of ditches.
-  **EMPLOI:** Broyeur d'accotement à grand déport pour nettoyage bord de routes etc.
-  **ANWENDUNG:** Für pflege von Strassenrandern, Gräben und Böschungen.
-  **UTILIZACION:** Idonea para limpieza banquetta, costado foso.

MODEL	A cm	B cm	C cm	D cm	E cm	F cm	G cm	H cm	L cm	M cm	P cm	S cm	T cm	U cm	 max Ø 1.5 cm				 min - max
FARMER 137	85	180	151	135	161	220	95	58	16	71	193	47	150	90	40	20	4	465	25 - 40
FARMER 167	85	210	178	162	161	247	122	58	16	71	193	47	150	90	48	24	4	495	30 - 50
FARMER 207	85	237	208	192	161	277	152	58	16	71	193	47	150	90	56	28	4	540	35 - 60
FARMER 237	85	279	235	220	161	305	180	58	16	71	193	47	150	90	64	32	4	595	50 - 70
FARMER 257	85	310	268	253	161	337	210	58	16	71	193	47	150	90	80	40	4	660	60 - 70

EQUIPAGGIAMENTO DI SERIE • STANDARD EQUIPMENT • DE SÉRIE • STANDARDSAUSSTATTUNG • ACESORIOS DE SERIE

- | | | | | |
|---|--|--|--|---|
| <ul style="list-style-type: none">  PDF 540 G/M CARDANO SNODO AUTOLIVELLANTE DOPIO TELAIO COFANO POSTERIORE APRIBILE PROTEZIONE ANTERIORE RULLO SPOSAMENTO LATERALE IDR. INCLINAZIONE IDRAULICA RUOTA LIBERA NEL GRUPPO CUSCINETTI OSCILLANTI DOPIE SFERE | <ul style="list-style-type: none">  PTO 540 RPM PTO SHAFT SELF LEVELLING LINK DOUBLE FRAME REAR OPENED BONNET FRONT SAFETY PROTECTION ROLLER HYDR. SIDE ADJUSTMENT HYDR. INCLINATION ADJUSTMENT GEARBOX W/FREE WHEEL SWINGING BEARING W/DOUBLE SPHERE | <ul style="list-style-type: none">  PDF 540 T/MIN CARDAN JOINT AUTO-NIVELLEMENT DOUBLE CHASSIS CAPOT AR. OUVRANT PROTECTION AVANT ROULEAU ARRIERE DEPORT LATERALE HYDRAULIQUE INCLINAISON HYDRAULIQUE ROUE LIBRE DANS BÔTIER ROULEMENT OSCILLANTS À DEUX RANGS DE BILLES | <ul style="list-style-type: none">  ZAPFWELLE 540 U/MIN GELENKWELLE SELBSTEINEBNUNG DOPPEL RAHMEN HINTERE HAUFMACHBARE HAUBE VORDERE SCHUTZ WALZE HYDR. SEITENVERSCHIEBUNG HYDRAULISCHE NEIGUNG GETRIEBE MIT FREILAUF SPHERESCHWINGENDE LAGER MIT DOPPEL KUGEL | <ul style="list-style-type: none">  TDF 540 RPM CARDAN SISTEMA AUTONIVELADOR DOBLE BASTIDOR COFRE POSTERIOR ABIERTO PROTECCION DELANTERA RODILLO DESPLAZAMIENTO LAT. HYDRAULICO INCLINACION HYDRAULICA RUEDA LIBRE EN LOS ENGRANAJES COJINETE OSCILANTE DOBLE SFERA |
|---|--|--|--|---|



FARMER 137

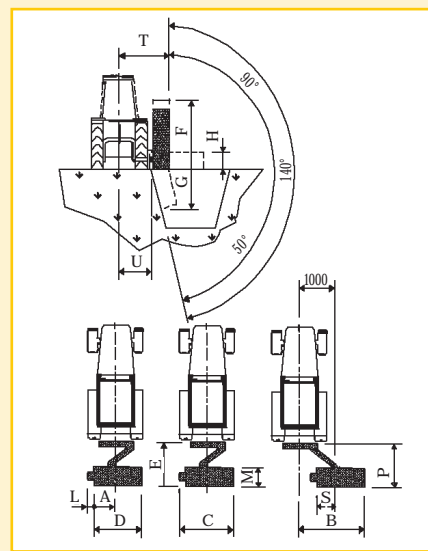

SNODO AUTOLIVELLANTE
 SELF LEVELLING LINK
 JOINT AUTO NIVELLEMENT
 SELBSTEINEBNUNG
 SISTEMA AUTONIVELADOR



DISPOSITIVO ANTI-SHOCK OLEOPNEUMATICO
 OLEOPNEUMATIC ANTI-SHOCK DEVICE
 DISPOSITIF OLEOPNEUMATIQUE ANTI-CHOC
 HYDROPNEMATISCH ANFAHRTSSCHERUNG
 SISTEMA ACEITENEUMATICO CONTRAGOLPE



FARMER 167



FARMER 257



FARMER 237