











farmer

137 | 167 | 207 | 237 | 257





Marciniak KG

Landmaschinen • Gartengeräte • Ersatzteile
 Stahlstr. / am Bahnhof
 D-30916 Isernhagen HB
 Tel.: 05 11 - 730 630
 Fax.: 05 11 - 73 31 51
 E-Mail: info@marciniak-landmaschinen.de
 Homepage: www.marciniak.info

-  **IMPIEGO:** Idonea per la pulizia di banchine stradali, bordi e sponde di fossati.
-  **USE:** Suitable for cleaning quay and side of ditches.
-  **EMPLOI:** Broyeur d'accotement à grand déport pour nettoyage bord de routes etc.
-  **ANWENDUNG:** Für pflege von Strassenrandern, Gräben und Böschungen.
-  **UTILIZACION:** Idonea para limpieza banquetta, costado foso.

MODEL	A cm	B cm	C cm	D cm	E cm	F cm	G cm	H cm	L cm	M cm	P cm	S cm	T cm	U cm	 max Ø 1.5 cm			 Kg	 min - max
FARMER 137	85	180	151	135	161	220	95	58	16	71	193	47	150	90	40	20	4	465	25 - 40
FARMER 167	85	210	178	162	161	247	122	58	16	71	193	47	150	90	48	24	4	495	30 - 50
FARMER 207	85	237	208	192	161	277	152	58	16	71	193	47	150	90	56	28	4	540	35 - 60
FARMER 237	85	279	235	220	161	305	180	58	16	71	193	47	150	90	64	32	4	595	50 - 70
FARMER 257	85	310	268	253	161	337	210	58	16	71	193	47	150	90	80	40	4	660	60 - 70

EQUIPAGGIAMENTO DI SERIE • STANDARD EQUIPMENT • DE SÉRIE • STANDARDSAUSSTATTUNG • ACESORIOS DE SERIE

-  PDF 540 G/M
CARDANO
SNODO AUTOLIVELLANTE
DOPPIO TELAIO
COFANO POSTERIORE APRIBILE
PROTEZIONE ANTERIORE
RULLO
SPOSAMENTO LATERALE IDR.
INCLINAZIONE IDRAULICA
RUOTA LIBERA NEL GRUPPO
CUSCINETTI OSCILLANTI
DOPPIE SFERE
-  PTO 540 RPM
PTO SHAFT
SELF LEVELLING LINK
DOUBLE FRAME
REAR OPENED BONNET
FRONT SAFETY PROTECTION
ROLLER
HYDR. SIDE ADJUSTMENT
HYDR. INCLINATION ADJUSTMENT
GEARBOX W/FREE WHEEL
SWINGING BEARING
W/DOUBLE SPHERE
-  PDF 540 T/MIN
CARDAN
JOINT AUTO-NIVELLEMENT
DOUBLE CHASSIS
CAPOT AR. OUVRANT
PROTECTION AVANT
ROULEAU ARRIERE
DEPORT LATERALE HYDRAULIQUE
INCLINAISON HYDRAULIQUE
ROUE LIBRE DANS BÔTIER
ROULEMENT OSCILLANTS À DEUX RANGS DE BILLES
-  ZAPFWELLE 540 U/MIN
GELENKWELLE
SELBSTEINEBNUNG
DOPPEL RAHMEN
HINTERE HAUFMACHBARE HAUBE
VORDERE SCHUTZ
WALZE
HYDR. SEITENVERSCHIEBUNG
HYDRAULISCHE NEIGUNG
GETRIEBE MIT FREILAUF
SPHERESCHWINGENDE LAGER MIT DOPPEL KUGEL
-  TDF 540 RPM
CARDAN
SISTEMA AUTONIVELADOR
DOBLE BASTIDOR
COFRE POSTERIOR ABIERTO
PROTECCION DELANTERA
RODILLO
DESPLAZAMIENTO LAT. HYDRAULICO
INCLINACION HYDRAULICA
RUEDA LIBRE EN LOS ENGRANAJES
COJINETE OSCILANTE DOBLE SFERA



FARMER 137

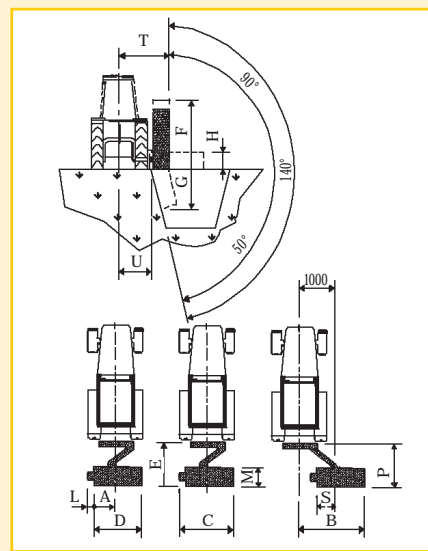

SNODO AUTOLIVELLANTE
 SELF LEVELLING LINK
 JOINT AUTO NIVELLEMENT
 SELBSTEINEBNUNG
 SISTEMA AUTONIVELADOR



FARMER 167



FARMER 257



FARMER 237



DISPOSITIVO ANTI-SHOCK OLEOPNEUMATICO
 OLEOPNEUMATIC ANTI-SHOCK DEVICE
 DISPOSITIF OLEOPNEUMATIQUE ANTI-CHOC
 HYDROPNEMATISCH ANFAHRTSSCHERUNG
 SISTEMA ACEITENEUMATICO CONTRAGOLPE