

energy

130 | 155

Marciniak KG

Landmaschinen • Gartengeräte • Ersatzteile

Stahlstr. / am Bahnhof
D-30916 Isernhagen HB
Tel.: 05 11 - 730 630
Fax.: 05 11 - 73 31 51E-Mail: info@marciniak-landmaschinen.de
Homepage: www.marciniak.info



 **IMPIEGO:** Trinciaerba leggera per minitrattori, idonea per prati, giardini, parchi ecc. La macchina può lavorare in svariate posizioni.

 **USE:** Light machine for mini-tractors. Suitable for greens, gardens, parks, etc. The machine can work in many positions.

 **EMPLOI:** Broyeur léger convenable pour prés, jardins, parcs, etc. La machine a la possibilité de travailler en plusieurs positions.

 **ANWENDUNG:** Leichte Maschine für Kleintraktoren, geeignet für Wiese, Garten, Parken, usw. Die Maschine hat die Möglichkeit in verschiedene Stellungen zu arbeiten.

 **UTILIZACION:** Máquina idonea para césped, jardines, parques, etc. La máquina puede trabajar en varias posiciones.

MODEL	A cm	B cm	C cm	D cm	E cm	F cm	G cm	H cm	L cm	M cm	P cm	S cm	T cm	U cm	 max Ø 1,5 cm	 Kg	 min - max	
ENERGY 130	72	186	140	132	104	140	69	30	8	52	130	47	123	73	64	3	210	15 - 20
ENERGY 155	72	209	163	155	104	163	85	30	8	52	130	47	123	73	80	3	230	15 - 25

EQUIPAGGIAMENTO DI SERIE • STANDARD EQUIPMENT • DE SÉRIE • STANDARDSAUSSTATTUNG • ACESORIOS DE SERIE

 PDF 540 G/M
CARDANO
SICUREZZA E AUTOLIVELLAMENTO
CON BIELLETTA
PROTEZIONE ANTERIORE
RULLO
SPOSAMENTO LATERALE IDR.
INCLINAZIONE IDRAULICA
RUOTA LIBERA NEL GRUPPO
SLITTE

 PTO 540 RPM
PTO SHAFT
SAFETY AND SELF LEVELLING
BREAKWAY COUPLING
FRONT SAFETY PROTECTION
ROLLER
HYDRAULIC SIDE ADJUSTMENT
HYDRAULIC INCLINATION
GEARBOX W/FREE WHEEL
SKIDS

 PDF 540 T/MIN
CARDAN
SÉCURITÉ ET AUTO-NIVELLEMENT
AVEC BIELLETTE
PROTECTION AVANT
ROULEAU
DÉPOT LATÉRALE HYDRAULIQUE
INCLINAISON HYDRAULIQUE
ROUE LIBRE DANS BÔTTIER
PATINS

 ZAPFWELLW 540 U/MIN
GELENKWELLE
ANFAHRTSSICHERUNG UND BODEN-
ANGLEICH. DURCH PLEUELSTANGE
VORDERE SCHUTZ
WALZE
HYDR. SEITENVERSCHIEBUNG
HYDRAULISCHE NEIGUNG
GETRIEBE MIT FREILAUF
KUFEN

 TDF 540 RPM
CARDAN
SEGURIDAD Y SISTEMA
AUTONIVELADOR CON BIELA
PTROTECCION DELANTERA
RODILLO
DESPLAZAMIENTO LAT. HYDRAULICO
INCLINACION HYDRAULICA
RUEDA LIBRE EN LOS ENGRANAJES
PATINES



ENERGY 155

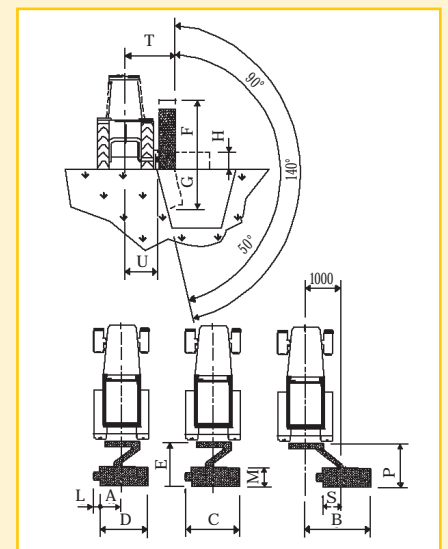

ENERGY 130



ENERGY 155



ENERGY 130